

PRODUCT SHEET

Description:

Sign Board Screw $\varnothing 13 \times 25$ mm, Alu, Anodized, M8, W/2 Trans- parent Washers

Item number:

22.11.128-0

Units	Box	Carton	HS Code	Barcode
Pcs.	60	360	8302490099	 5704866084239

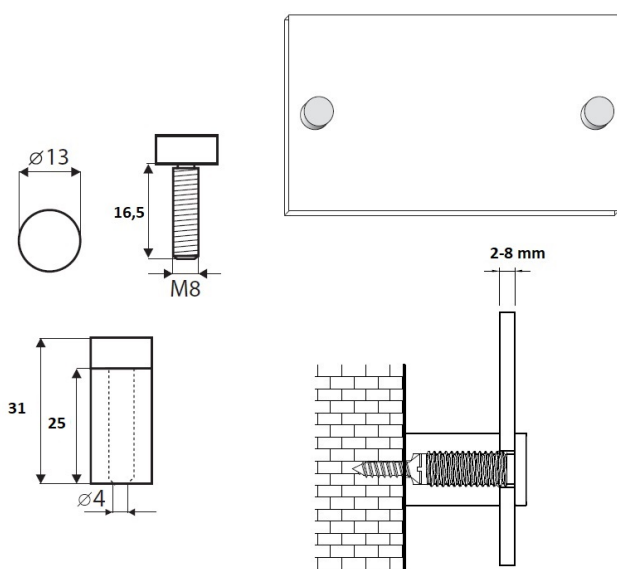

SISO A/S

Mileparken 11
DK-2740 Skovlunde
Denmark
VAT: DK 24786013

Phone +45 45 830 900

www.siso.dk
siso@siso.dk

Danske Bank
Nytorv Branch
Copenhagen
SWIFT: DABADKKK

Account no.
4180 3112 112936
IBAN Account
DK7230003112112936